

TP600 and TP400 Control Panels

User Interface and Programming Reference – Standard Menus

System Model:	BP-Series Systems are BP5XX, BP6XX, BP1XXX, BP2XXX..	
Software Version:	7.0 and later	
Panel Model:	TP600 Series	TP400 Series
Software Version:	2.3 or later	2.4 or later



Manufactured under one or more of these patents. U.S. Patents: 5332944, 5361215, 5550753, 5559720, 5,883,459, 6253227, 6282370, 6590188, 6976052, 6965815, 7030343, 7,417,834 b2, Canadian Patent: 2342614, Australian patent: 2373248 other patents both foreign and domestic applied for and pending. All material copyright of Balboa Water Group.

BALBOA
water group

Main Menus

Navigation

Navigating the entire menu structure is done with 2 or 3 buttons on the control panel.



Some panels have separate **WARM** (Up) and **COOL** (Down) buttons, while others have a single **Temperature** button. In the navigation diagrams Temperature buttons are indicated by a single button icon.

Panels that have two Temperature buttons (Warm and Cool) can use both of them to simplify navigation and programming where a single Temperature icon is shown.

The **LIGHT** Button is also used to choose the various menus and navigate each section.

Typical use of the Temperature button(s) allows changing the Set Temperature while the numbers are flashing in the LCD.

Pressing the **LIGHT** button while the numbers are flashing will enter the menus.

The menus can be exited with certain button presses. Simply waiting for a few seconds will return the panel operation to normal.

Power-up Screens

Each time the System powers up, a series of numbers is displayed.

After the startup sequence of numbers, the system will enter Priming Mode (See Page 3).

Key

- Indicates Flashing or Changing Segment
- Indicates Alternating or Progressive Message - every 1/2 second
- ⏏ A temperature button, used for "Action"
- ⚙ Light or dedicated "Choose" button, depending on control panel configuration
- Waiting time that keeps the last change to a menu item.
- ***** Waiting time (depends on menu item) that reverts to original setting and ignores any change to that menu item.

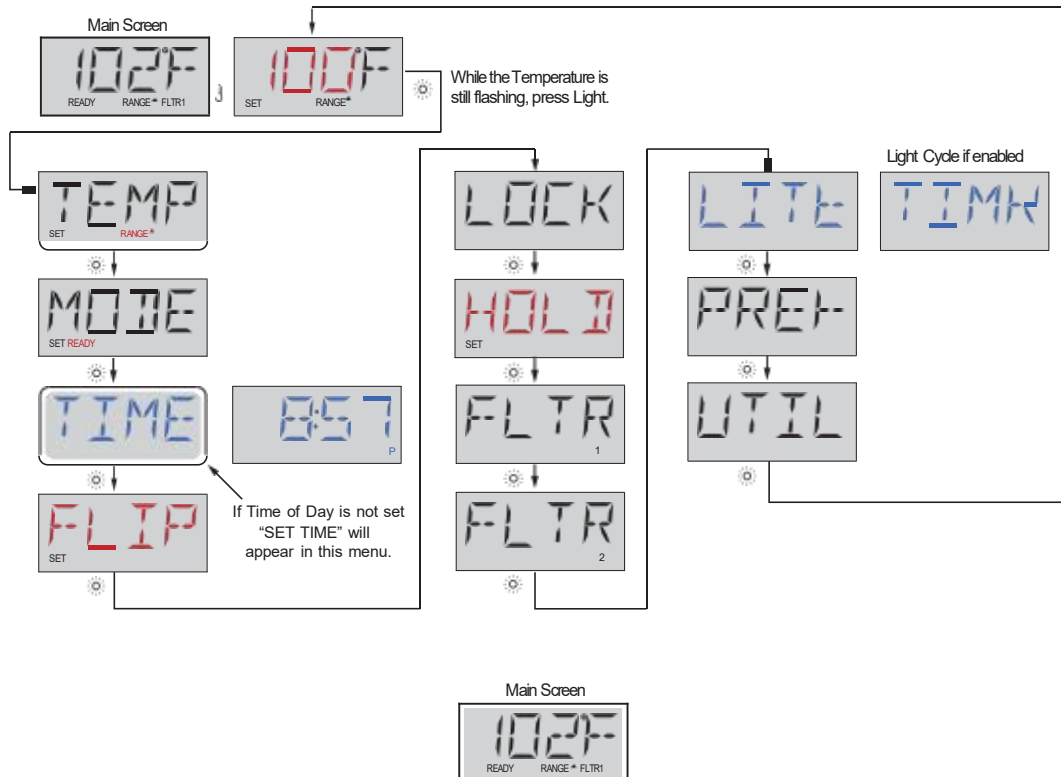

Indicates a Menu Item that Depends on a Manufacturer Configuration and may or may not appear.

Waiting a few seconds in the Main Menu will allow the display to revert to the Main Screen. Most changes are not saved unless Light: ⚙ is pressed. Refer to key above.

Fill it up!

Preparation and Filling

Fill the spa to its correct operating level. Be sure to open all valves and jets in the plumbing system before filling to allow as much air as possible to escape from the plumbing and the control system during the filling process.

After turning the power on at the main power panel, the top-side panel display will go through specific sequences. These sequences are normal and display a variety of information regarding the configuration of the hot tub control.

Priming Mode – M019*

This mode will last for 4-5 minutes or you can manually exit the priming mode after the pump(s) have primed.



Regardless of whether the priming mode ends automatically or you manually exit the priming mode, the system will automatically return to normal heating and filtering at the end of the priming mode. During the priming mode, the heater is disabled to allow the priming process to be completed without the possibility of energizing the heater under low-flow or no-flow conditions. Nothing comes on automatically, but the pump(s) can be energized by pushing the “Jet” buttons. If the spa has a Circ Pump, it can be activated by pressing the “Light” button during Priming Mode.

Priming the Pumps

As soon as the above display appears on the panel, push the “Jet” button once to start Pump 1 in low-speed and then again to switch to high-speed. Also, push the “Aux” button, if you have a 2nd pump, to turn it on. The pumps will now be running in high-speed to facilitate priming. If the pumps have not primed after 2 minutes, and water is not flowing from the jets in the spa, do not allow the pumps to continue to run. Turn off the pumps and repeat the process. Note: Turning the power off and back on again will initiate a new pump priming session. Sometimes momentarily turning the pump off and on will help it to prime. Do not do this more than 5 times. If the pump(s) will not prime, shut off the power to the spa and call for service.

Important: A pump should not be allowed to run without priming for more than 2 minutes. Under NO circumstances should a pump be allowed to run without priming beyond the end of the 4-5 minute priming mode. Doing so may cause damage to the pump and cause the system to energize the heater and go into an overheat condition.

Exiting Priming Mode

You can manually exit Priming Mode by pressing a “Temp” button (Up or Down). Note that if you do not manually exit the priming mode as described above, the priming mode will be automatically terminated after 4-5 minutes. Be sure that the pump(s) have been primed by this time.

Once the system has exited Priming Mode, the top-side panel will momentarily display the set temperature but the display will not show the temperature yet, as shown below. This is because the system requires approximately 1 minute of water



flowing through the heater to determine the water temperature and display it.

*M019 is a Message Code. See Page 18.

Spa Behavior

Pumps

Press the “Jets 1” button once to turn pump 1 on or off, and to shift between low- and high-speeds if equipped. If left running, the pump will turn off after a time-out period. The pump 1 low-speed will time out after 30 minutes. The high-speed will time out after 15 minutes.

On non-circ systems, the low-speed of pump 1 runs when the blower or any other pump is on. If the spa is in Ready Mode (See page 6), Pump 1 low may also activate for at least 1 minute every 30 minutes to detect the spa temperature (polling) and then to heat to the set temperature if needed. When the low-speed turns on automatically, it cannot be deactivated from the panel, however the high speed may be started.

Circulation Pump Modes

If the system is equipped with a circ pump, it will be configured to work in one of three different ways:

- 1, The circ pump operates continuously (24 hours) with the exception of turning off for 30 minutes at a time when the water temperature reaches 3°F (1.5°C) above the set temperature (most likely to happen in very hot climates).
- 2, The circ pump stays on continuously, regardless of water temperature.
- 3, A programmable circ pump will come on when the system is checking temperature (polling), during filter cycles, during freeze conditions, or when another pump is on.

The specific Circulation Mode that is used has been determined by the Manufacturer and cannot be changed in the field.

Filtration and Ozone

On non-circ systems, Pump 1 low and the ozone generator will run during filtration. On circ systems, the ozone will run with the circ pump.

The system is factory-programmed with one filter cycle that will run in the evening (assuming the time-of-day is properly set) when energy rates are often lower. The filter time and duration are programmable. (See page 10)
A second filter cycle can be enabled as needed.

At the start of each filter cycle, the blower (if there is one) or Pump 2 (if there is one) will run briefly to purge its plumbing to maintain good water quality.

Freeze Protection

If the temperature sensors within the heater detect a low enough temperature, then the pump(s) and the blower automatically activate to provide freeze protection. The pump(s) and blower will run either continuously or periodically depending on conditions.

In colder climates, an optional additional freeze sensor may be added to protect against freeze conditions that may not be sensed by the standard sensors. Auxiliary freeze sensor protection acts similarly except with the temperature thresholds determined by the switch. See your dealer for details.

Clean-up Cycle (optional)

When a pump or blower is turned on by a button press, a clean-up cycle begins 30 minutes after the pump or blower is turned off or times out. The pump and the ozone generator will run for 30 minutes or more, depending on the system. On some systems, you can change this setting. (See the Preferences section on page 12)

Temperature and Temp Range

Adjusting the Set Temperature

When using a panel with Up and Down buttons (Temperature buttons), pressing Up or Down will cause the temperature to flash. Pressing a temperature button again will adjust the set temperature in the direction indicated on the button. When the LCD stops flashing, the spa will heat to the new set temperature when required.

If the panel has a single temperature button, pressing the button will cause the temperature to flash. Pressing the button again will cause the temperature to change in one direction (e.g. UP). After allowing the display to stop flashing, pressing the Temperature Button will cause the temperature to flash and the next press will change the temperature in the opposite direction (e.g. DOWN).

Press-and-Hold

If a Temperature button is pressed and held when the temperature is flashing, the temperature will continue to change until the button is released. If only one temperature button is available and the limit of the Temperature Range is reached when the button is being held, the progression will reverse direction.

Dual Temperature Ranges

This system incorporates two temperature range settings with independent set temperatures. The High Range designated in the display by an “up” arrow, and the Low Range designated in the display by a “down” arrow.

These ranges can be used for various reasons, with a common use being a “ready to use” setting vs. a “vacation” setting. The Ranges are chosen using the menu structure below. Each range maintains its own set temperature as programmed by the user. This way, when a range is chosen, the spa will heat to the set temperature associated with that range.

For example:

High Range might be set between 80°F and 104°F.

Low Range might be set between 50°F and 99°F.

More specific Temp Ranges may be determined by the Manufacturer.

Freeze Protection is active in either range.

See Ready and Rest on Page 6

for additional heating control information.

Key

- Indicates Flashing or Changing Segment
- Indicates Alternating or Progressive Message - every 1/2 second
- ↓ A temperature button, used for “Action”
- ☼ Light or dedicated “Choose” button, depending on control panel configuration
- ***** Waiting time that keeps the last change to a menu item.
- ***** Waiting time (depends on menu item) that reverts to original setting and ignores any change to that menu item.

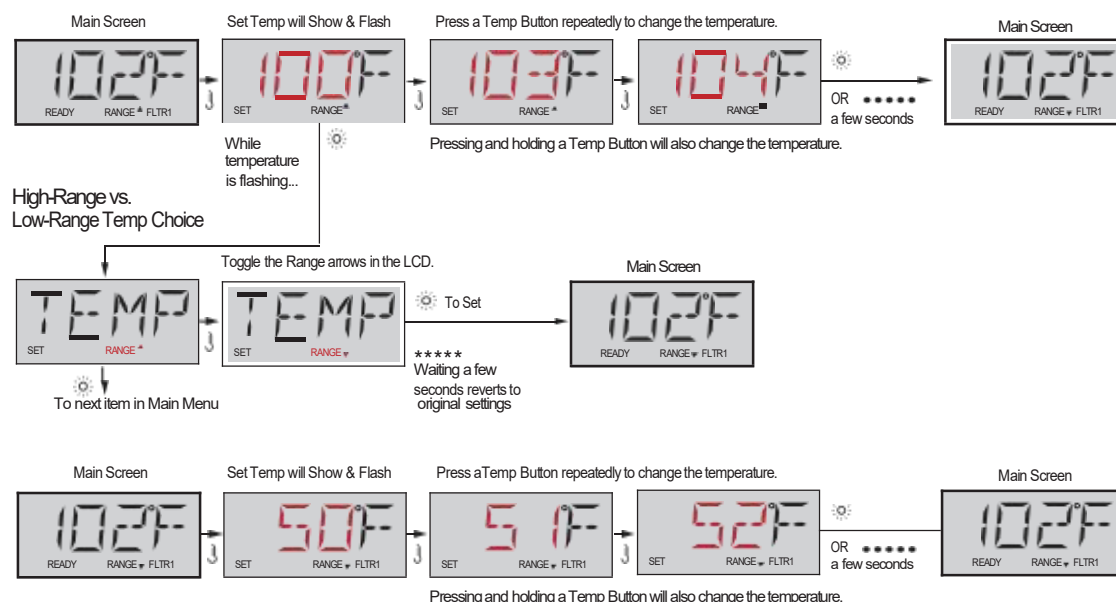

Mode – Ready and Rest

In order for the spa to heat, a pump needs to circulate water through the heater. The pump that performs this function is known as the “heater pump.”

The heater pump can be either a 2-Speed Pump 1 or a circulation pump.

If the heater pump is a 2-Speed Pump 1, READY Mode will circulate water periodically, using Pump 1 Low, in order to maintain a constant water temperature, heat as needed, and refresh the temperature display. This is known as “polling.”

REST Mode will only allow heating during programmed filter cycles. Since polling does not occur, the temperature display may not show a current temperature until the heater pump has been running for a minute or two.

Circulation Mode (See Page 4, under Pumps, for other circulation modes)

If the spa is configured for 24HR circulation, the heater pump generally runs continuously. Since the heater pump is always running, the spa will maintain set temperature and heat as needed in Ready Mode, without polling.

In Rest Mode, the spa will only heat to set temperature during programmed filter times, even though the water is being filtered constantly when in Circulation Mode.

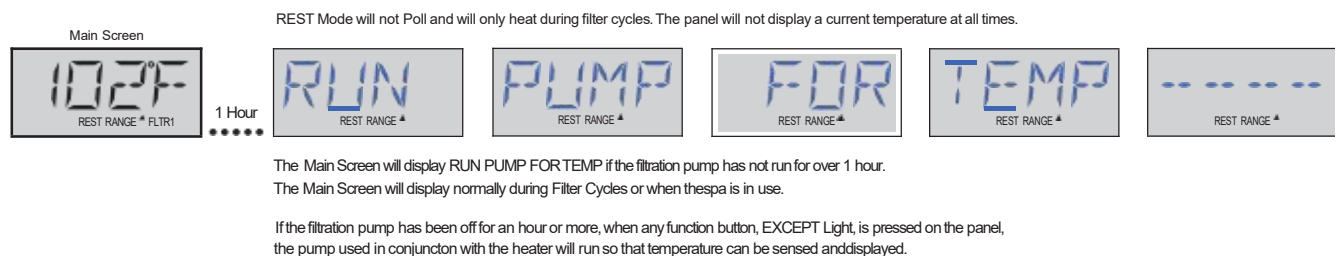
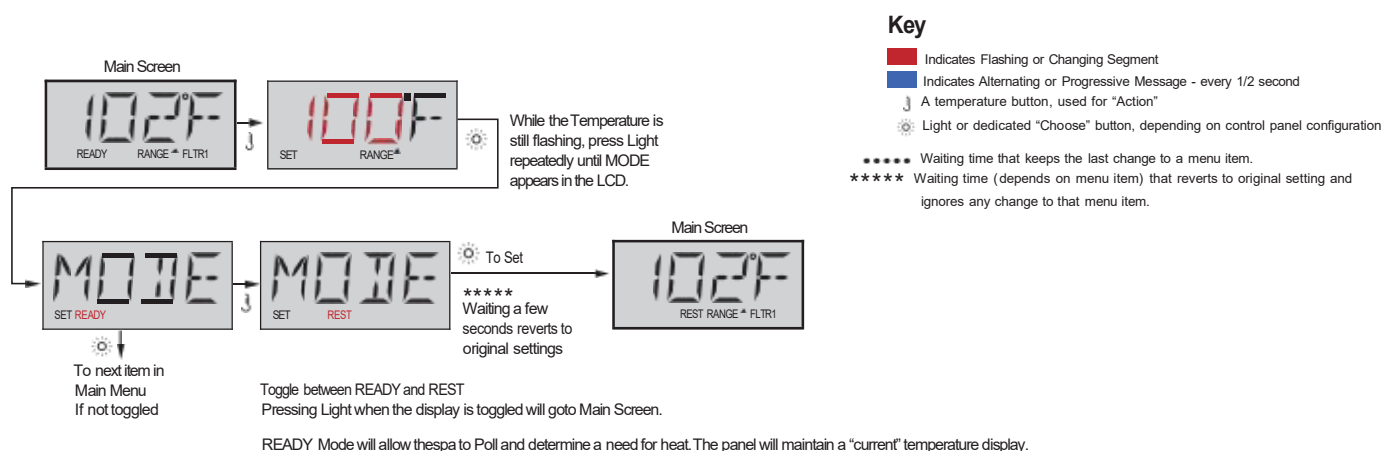

Ready-in-Rest Mode

READY/REST appears in the display if the spa is in Rest Mode and Jet 1 is pressed. It is assumed that the spa is being used and will heat to set temperature. While Pump 1 High can be turned on and off, Pump 1 Low will run until set temperature is reached, or 1 hour has passed. After 1 hour, the System will revert to Rest Mode. This mode can also be reset by entering the Mode Menu and changing the Mode.

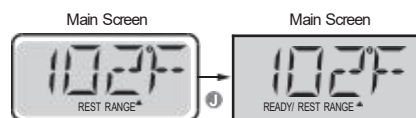

Restricting Operation

The control can be restricted to prevent unwanted use or temperature adjustments.

Locking the panel prevents the controller from being used, but all automatic functions are still active.

Locking the Temperature allows Jets and other features to be used, but the Set Temperature and other programmed settings cannot be adjusted.

Temperature Lock allows access to a reduced selection of menu items.

These include Set Temperature, FLIP, LOCK, UTIL, INFO and FALT LOG.

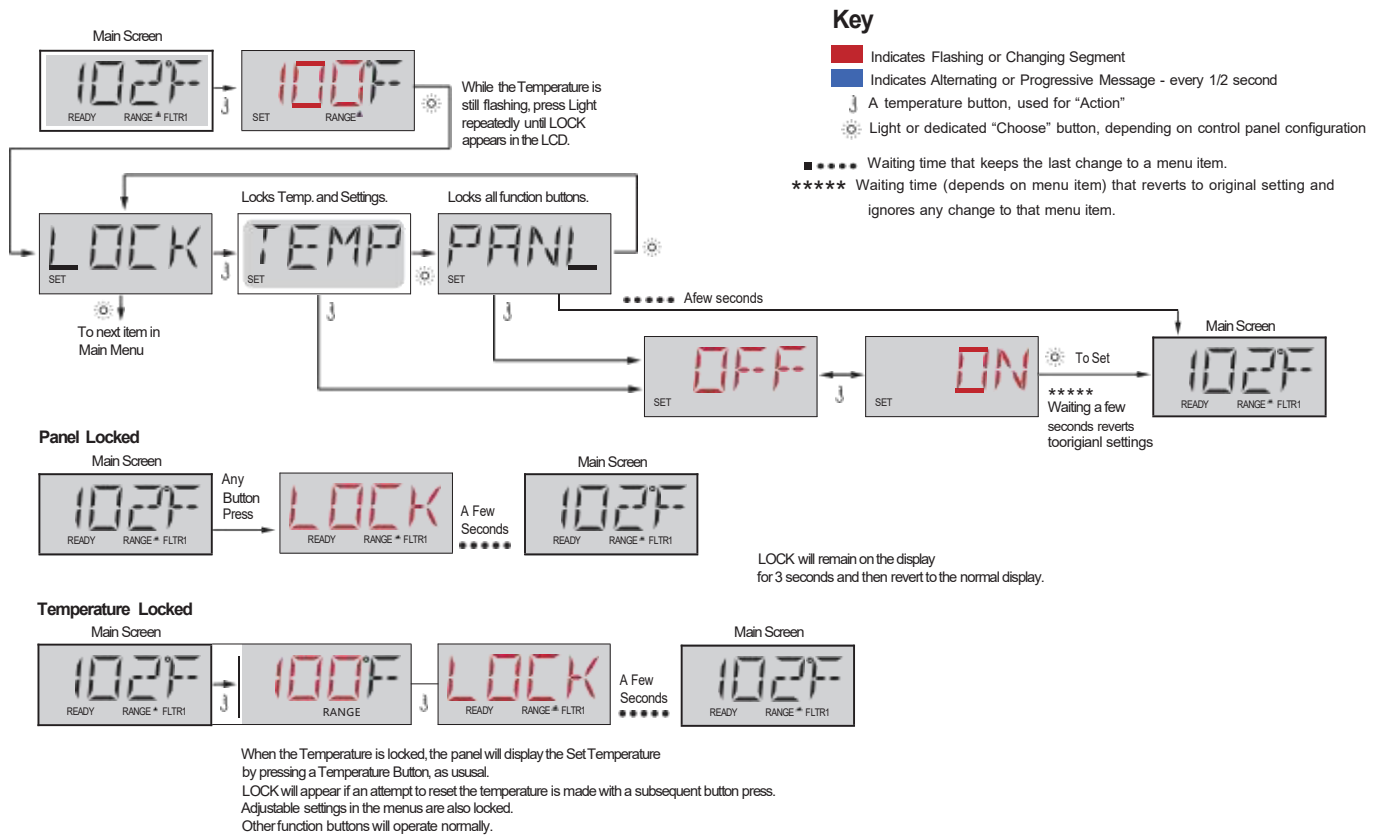

Unlocking

This Unlock sequence may be used from any screen that may be displayed on a restricted panel.

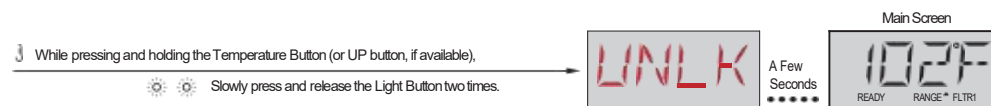

NOTE: If the panel has both an UP and a Down button, the **ONLY** button that will work in the Unlock Sequence is the UP button.

Hold (Standby)

Hold Mode – M037*

Hold Mode is used to disable the pumps during service functions like cleaning or replacing the filter. Hold Mode will last for 1 hour unless the mode is exited manually.

Drain Mode

Some spas have a special feature that allows a pump to be employed when draining the water. When available, this feature is a component of Hold Mode.

Key

- Indicates Flashing or Changing Segment
- Indicates Alternating or Progressive Message - every 1/2 second
- ⌵ A temperature button, used for "Action"
- ☼ Light or dedicated "Choose" button, depending on control panel configuration
- ***** Waiting time that keeps the last change to a menu item.
- ***** Waiting time (depends on menu item) that reverts to original setting and ignores any change to that menu item.

Indicates a Menu Item that Depends on a Manufacturer Configuration and may or may not appear.



M037 is a Message Code. See Page 18.



Manufactured under one or more of these patents. U.S. Patents: 5332944, 5361215, 5550753, 5559720, 5,883,459, 6253227, 6282370, 6590188, 6976052, 6965815, 7030343, 7,417,834 b2, Canadian Patent: 2342614, Australian patent: 2373248 other patents both foreign and domestic applied for and pending. All material copyright of Balboa Water Group.



Adjusting Filtration

Main Filtration

Filter cycles are set using a start time and a duration. Start time is indicated by an "A" or "P" in the bottom right corner of the display. Duration has no "A" or "P" indication. Each setting can be adjusted in 15-minute increments. The panel calculates the end time and displays it automatically.

Key

- Indicates Flashing or Changing Segment
- Indicates Alternating or Progressive Message - every 1/2 second
- ⏏ A temperature button, used for "Action"
- ⚙ Light or dedicated "Choose" button, depending on control panel configuration
- ***** Waiting time that keeps the last change to a menu item.
- ***** Waiting time (depends on menu item) that reverts to original setting and ignores any change to that menu item.

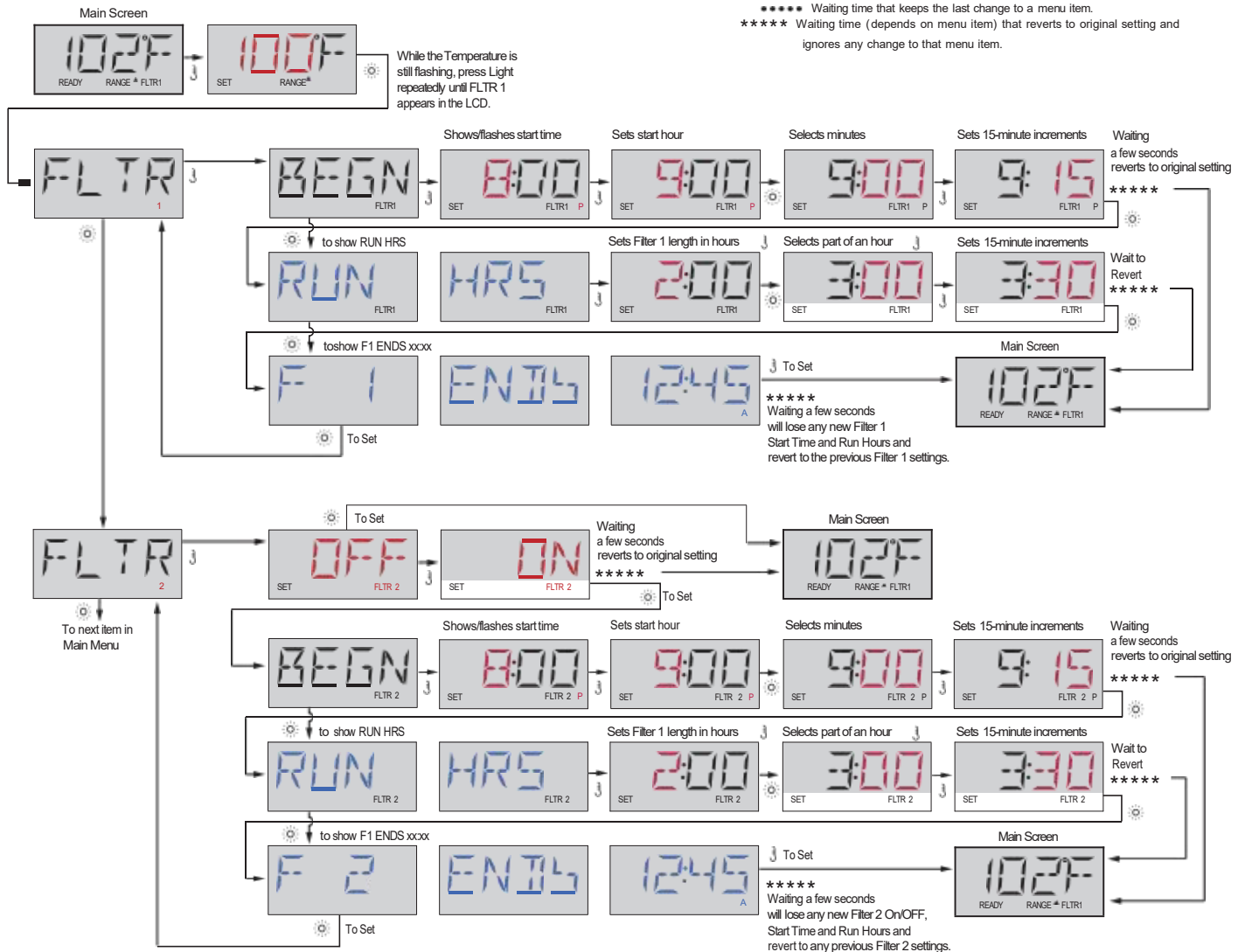

Filter Cycle 2 - Optional Filtration

Filter Cycle 2 is OFF by default.

It is possible to overlap Filter Cycle 1 and Filter Cycle 2, which will shorten overall filtration by the overlap amount.

Purge Cycles

In order to maintain sanitary conditions, secondary Pumps and/or a Blower will purge water from their respective plumbing by running briefly at the beginning of each filter cycle.

If Filter Cycle 1 is set for 24 hours, enabling Filter Cycle 2 will initiate a purge when Filter Cycle 2 is programmed to begin.

Light Timer Programming

Light Timer Option

If LITE TIMR does not appear in the Main Menu, the Light Timer feature is not enabled by the manufacturer.

When available, the Light Timer is OFF by default.

Key

- Indicates Flashing or Changing Segment
- Indicates Alternating or Progressive Message - every 1/2 second
- ↓ A temperature button, used for "Action"
- ☰ Light or dedicated "Choose" button, depending on control panel configuration
- ***** Waiting time that keeps the last change to a menu item.
- ***** Waiting time (depends on menu item) that reverts to original setting and ignores any change to that menu item.

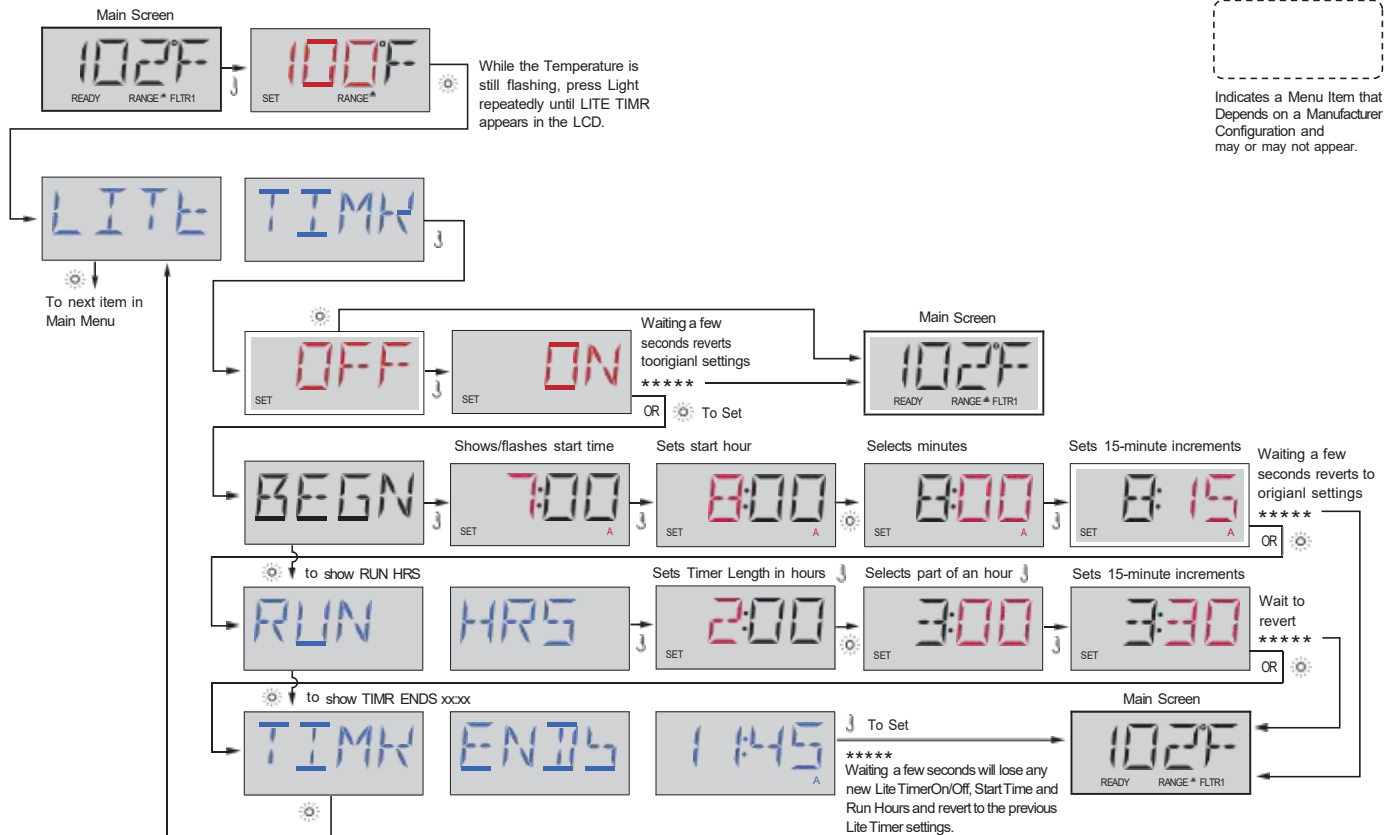

Preferences

F / C (Temp Display)

Change the temperature between Fahrenheit and Celsius.

12 / 24 (Time Display)

Change the clock between 12 hr and 24 hr display.

RE-MIN-DERS (Reminders)

Turn the reminder messages (like "Clean Filter") On or Off.

CLN-UP (Cleanup)

Cleanup Cycle Duration is not always enabled, so it may not appear. When it is available, set the length of time Pump 1 will run after each use. 0-4 hours are available.

DOL-PHIN AD-DRES (Dolphin II and Dolphin III) Applies to RF Dolphin only. (This message may not appear depending on the configuration)

When set to 0, no addressing is used. Use this setting for a Dolphin Remote which is factory set for no address by default. When set between 1 and 7, the number is the address. (See the Dolphin manual for details.)

Preferences

Key

- █ Indicates Flashing or Changing Segment
- █ Indicates Alternating or Progressive Message - every 1/2 second
- ⏴ A temperature button, used for "Action"
- ⚙ Light or dedicated "Choose" button, depending on control panel configuration
- ***** Waiting time that keeps the last change to a menu item.
- ***** Waiting time (depends on menu item) that reverts to original setting and ignores any change to that menu item.

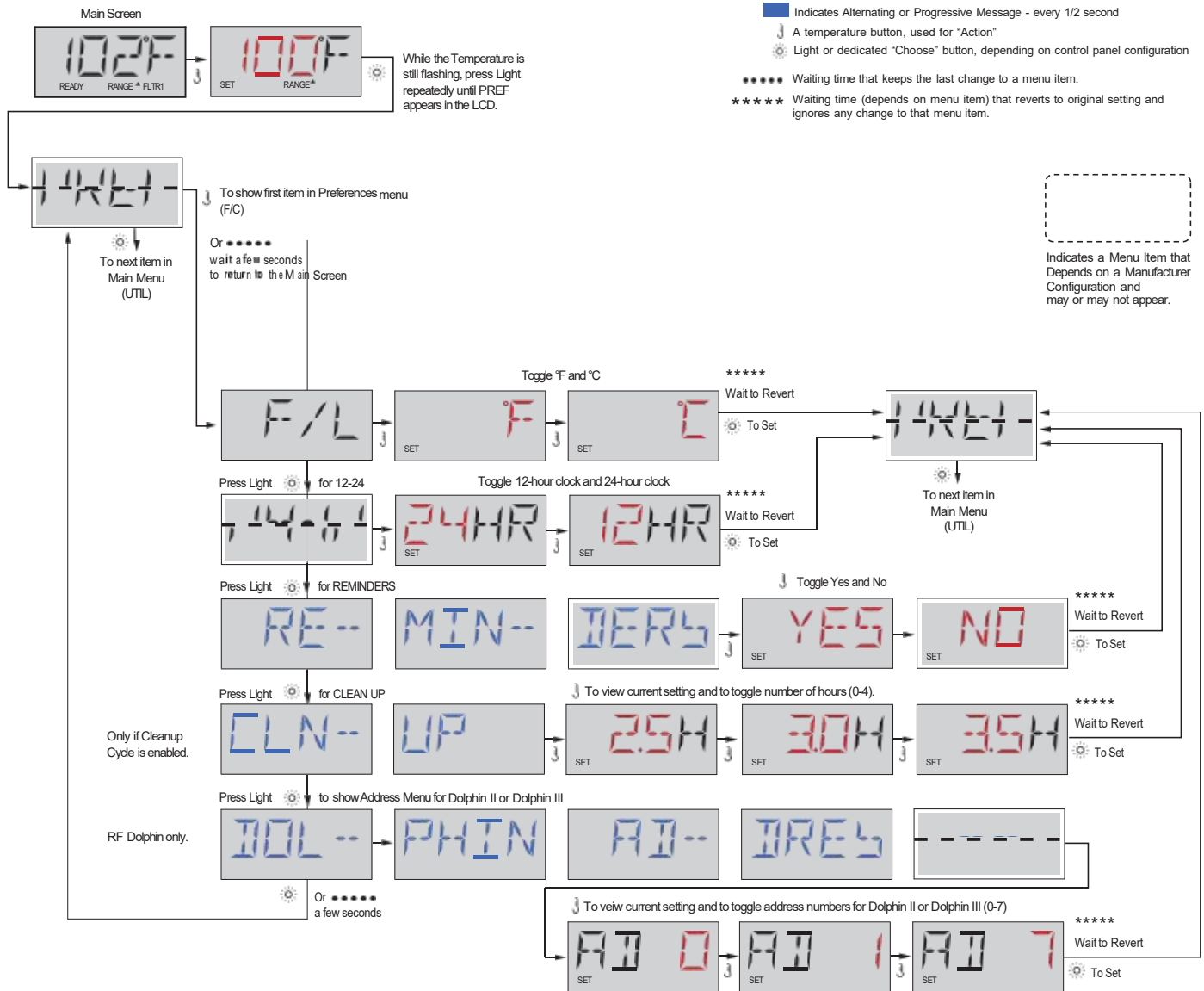

Utilities and Information

INFO (System Information sub-menu)

The System Information Menu displays various settings and identification of the particular system. As each item in the menu is highlighted, the detail for that item is displayed at the bottom of the screen.

SSID (Software ID)

Displays the software ID number for the System.

MODL (System Model)

Displays the Model Number of the System.

SETP (Current Setup)

Displays the currently selected Configuration Setup Number.

Heater Voltage (Feature not used on CE rated systems.)

Displays the operating voltage configured for the heater.

Heater Wattage as Configured in Software (CE Systems Only.)

Displays a heater kilowatt rating as programmed into the control system software (1-3 or 3-6).

H _ (Heater Type)

Displays a heater type ID number.

SW _ (Dip Switch Settings)

Displays a number that represents the DIP switch positions of S1 on the main circuit board.

PANL (Panel Version)

Displays a number of the software in the topside control panel.

Additional Utilities

Utilities

In addition to INFO, The Utilities Menu contains the following:

GFCI (GFCI Test) **(Feature not available on CE rated systems.)**

GFCI Test is not always enabled, so it may not appear. This screen allows the GFCI to be tested manually from the panel and can be used to reset the automatic test feature. If the GFCI Test Feature is reset, the device will trip within 7 days. (See Page 17)

A / B (A/B Sensor Temperatures)

When this is set to On, the temperature display will alternate to display temperature from Sensor A and Sensor B in the heater.

FALT LOG (Fault Log)

The Fault Log is a record of the last 24 faults that can be reviewed by a service tech.

DEMO (Demo Mode)

Demo Mode is not always enabled, so it may not appear. This is designed to operate several devices in a sequence in order to demonstrate the various features of a particular hot tub.

Utilities

Key

- Indicates Flashing or Changing Segment
- Indicates Alternating or Progressive Message - every 1/2 second
- ⌵ A temperature button, used for "Action"
- ⊙ Light or dedicated "Choose" button, depending on control panel configuration

***** Waiting time that keeps the last change to a menu item.

***** Waiting time (depends on menu item) that reverts to original setting and ignores any change to that menu item.

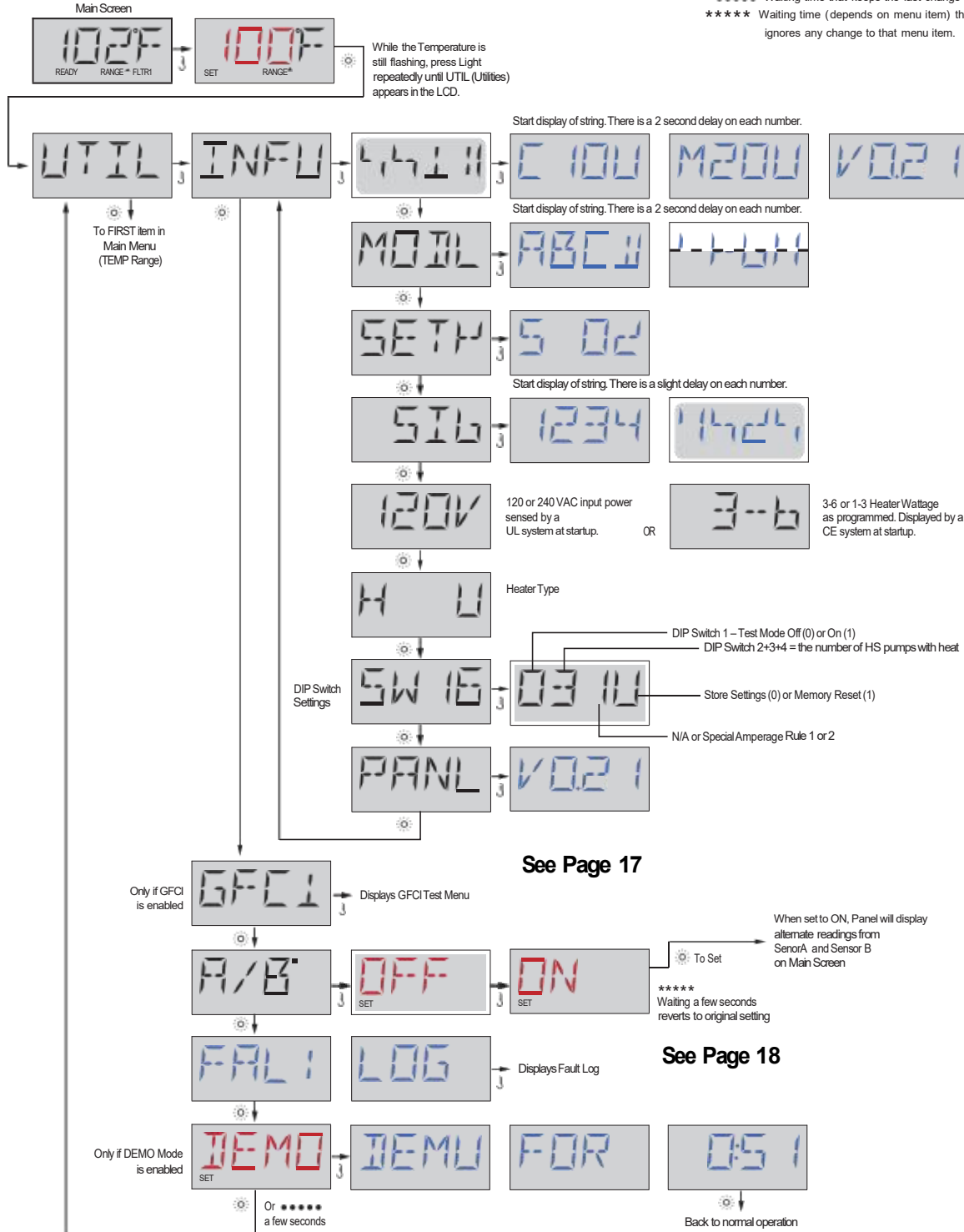

These strings will display once and return to the beginning. Press Temperature again to display the string again.

***** Waiting 10 seconds will allow the screen to return to normal operation.

Indicates a Menu Item that Depends on a Manufacturer Configuration and may or may not appear.

Utilities – GFCI Test Feature

Not Available on CE Rated Systems.

A GFCI is an important safety device and is required equipment on a hot tub installation.

Your spa may be equipped with a GFCI Protection feature. (UL rated systems only.) If your spa has this feature enabled by the manufacturer, the GFCI Trip Test must occur to allow proper spa function.

Within 1 to 7 days after startup, the spa will trip the GFCI to test it. (The number of days is factory programmed.) The GFCI must be reset once it has tripped. After passing the GFCI Trip Test, any subsequent GFCI trips will indicate a ground fault or other unsafe condition and the power to the spa must be shut off until a service person can correct the problem.

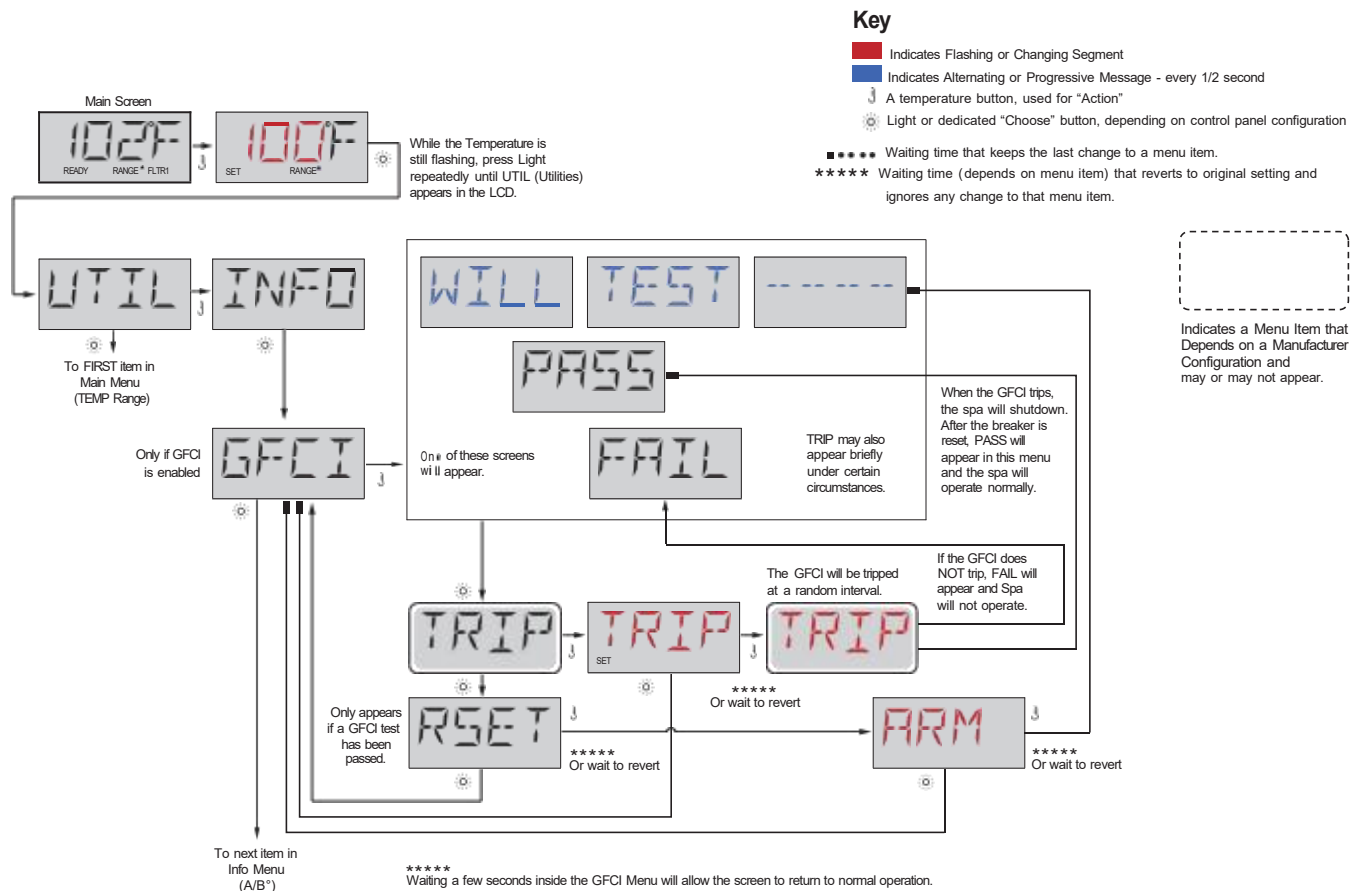

Forcing the GFCI Trip Test

The installer can cause the GFCI Trip Test to occur sooner by initiating it using the above menu.

The GFCI should trip within a few seconds and the spa should shutdown. If it does not, shutdown the power and manually verify that a GFCI breaker is installed and that the circuit and spa are wired correctly. Verify the function of the GFCI with its own test button. Restore power to the spa and repeat the GFCI Trip Test.

Once the GFCI is tripped by the test, reset the GFCI and the spa will operate normally from that point. You can verify a successful test by navigating to the above menu. PASS should appear after a temp button is pressed from the GFCI screen.

The end-user must be trained to expect this one-time test to occur and how to properly reset the GFCI.

Warning:

If freezing conditions exist, a GFCI should be reset immediately or spa damage could result. The end user should always trained to test and reset the GFCI on a regular basis.

Utilities – Fault Log

A Little History can tell a lot

The Fault Log stores up to 24 events in memory and they can be reviewed under the Fault Log Menu.

Each event captures a Fault Message Code, how many days have passed since the fault, Time of the fault, Set Temperature during the fault, and Sensor A and B temperatures during the fault.

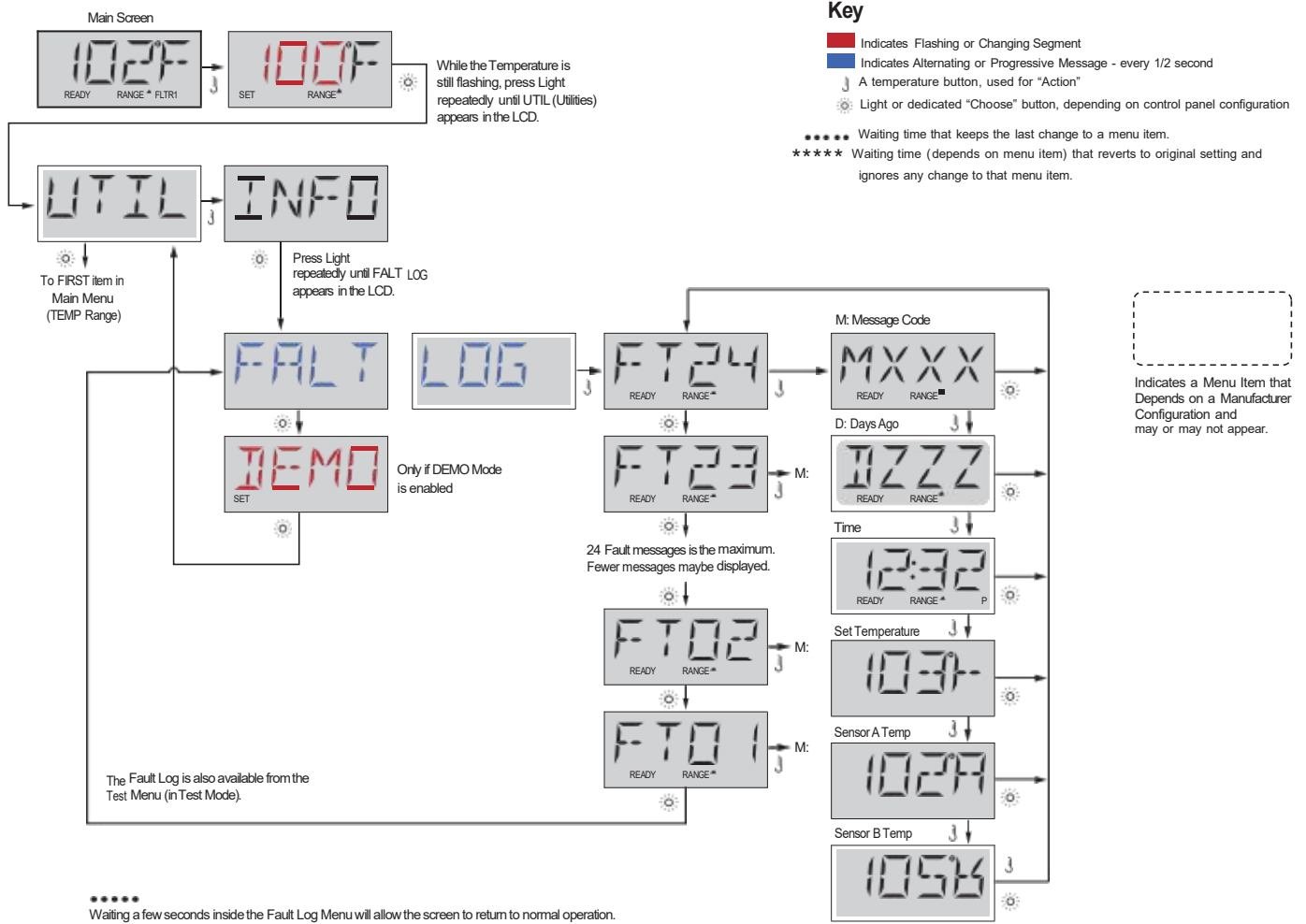

See following pages for various Message Codes and definitions.

General Messages



Priming Mode – M019

Each time the spa is powered up, it will enter Priming Mode. The purpose of Priming Mode is to allow the user to run each pump and manually verify that the pumps are primed (air is purged) and water is flowing. This typically requires observing the output of each pump separately, and is generally not possible in normal operation. Priming Mode lasts 4 minutes, but you can exit it earlier by pressing any Temp button. The heater is not allowed to run during Priming Mode.

NOTE: If your spa has a Circ Pump, it will turn on with Jets 1 in Priming Mode. The Circ Pump will run by itself when Priming Mode is exited.



Water Temperature is Unknown

After the pump has been running for 1 minute, the temperature will be displayed.

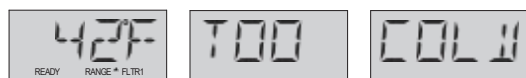

Too Cold - Freeze Protection

A potential freeze condition has been detected, or the Aux Freeze Switch has closed, and all pumps and blower are activated. All pumps and blower are ON for at least 4 minutes after the potential freeze condition has ended, or when the aux freeze switch opens.

In some cases, pumps may turn on and off and the heater may operate during Freeze Protection.

This is an operational message, not an error indication.



Water is too Hot (OHS) – M029

One of the water temp sensors has detected spa water temp 110°F (43.3°C) and spa functions are disabled. System will auto reset when the spa water temp is below 108°F (42.2°C). Check for extended pump operation or high ambient temp.



Safety Trip - Pump Suction Blockage* – M033

The Safety Trip error message indicates that the vacuum switch has closed. This occurs when there has been a suction problem or a possible entrapment situation avoided. (Note: not all spas have this feature.)

M0XX numbers are Message Codes. See Page 18.

* This message can be reset from the topside panel with any button press.

Heater-Related Messages



Heater Flow is Reduced (HFL) – M016

There may not be enough water flow through the heater to carry the heat away from the heating element. Heater start up will begin again after about 1 min. See “Flow Related Checks” below.



Heater Flow is Reduced (LF)* – M017

There is not enough water flow through the heater to carry the heat away from the heating element and the heater has been disabled. See “Flow Related Checks” below. After the problem has been resolved, you must press any button to reset and begin heater start up.



Heater may be Dry (dr)* – M028

Possible dry heater, or not enough water in the heater to start it. The spa is shutdown for 15 min. Press any button to reset the heater start-up. See “Flow Related Checks” below.



Heater is Dry* – M027

There is not enough water in the heater to start it. The spa is shutdown. After the problem has been resolved, you must press any button to reset and restart heater start up. See “Flow Related Checks” below.

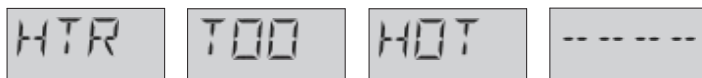

Heater is too Hot (OHH)* – M030

One of the water temp sensors has detected 118°F (47.8°C) in the heater and the spa is shutdown. You must press any button to reset when water is below 108°F (42.2°C). See “Flow Related Checks” below.



A Reset Message may Appear with other Messages.

Some errors may require power to be removed and restored.

Flow-Related Checks

Check for low water level, suction flow restrictions, closed valves, trapped air, too many closed jets and pump prime.

On some systems even when spa is shutdown, some equipment may occasionally turn on to continue monitoring temperature or if freeze protection is needed.

* This message can be reset from the topside panel with any button press.

Sensor-Related Messages

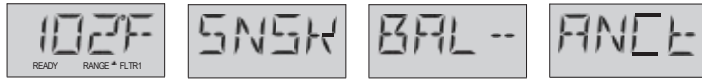

Sensor Balance is Poor – M015

The temperature sensors MAY be out of sync by 2°F or 3°F. Call for Service.



Sensor Balance is Poor* – M026

The temperature sensors ARE out of sync. The Sensor Balance is Poor fault has been established for at least 1 hour. Call for Service.



Sensor Failure – Sensor A: M031, Sensor B: M032

A temperature sensor or sensor circuit has failed. Call for Service.

Miscellaneous Messages



No Communications

The control panel is not receiving communication from the System. Call for Service.



Pre-Production Software

The Control System is operating with test software. Call for Service.



°F or °C is replaced by °T

The Control System is in Test Mode. Call for Service.

* This message can be reset from the topside panel with any button press.

System-Related Messages



Memory Failure - Checksum Error* – M022

At Power-Up, the system has failed the Program Checksum Test. This indicates a problem with the firmware (operation program) and requires a service call.

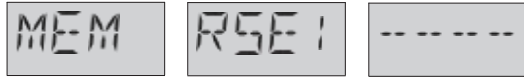

Memory Warning - Persistent Memory Reset* – M021

Appears after any system setup change. Contact your dealer or service organization if this message appears on more than one power-up, or if it appears after the system has been running normally for a period of time.

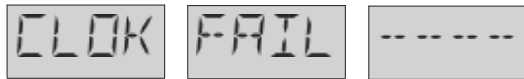

Memory Failure - Clock Error* – M020 - Not Applicable on the BP1500

Contact your dealer or service organization.

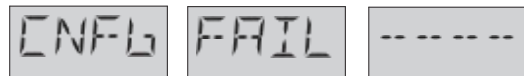

Configuration Error – Spa will not Start Up

Contact your dealer or service organization.

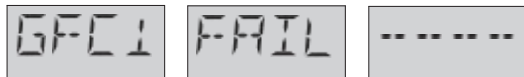

GFCI Failure - System Could Not Test/Trip the GFCI – M036

NORTH AMERICA ONLY. May indicate an unsafe installation. Contact your dealer or service organization.



A Pump Appears to be Stuck ON – M034

Water may be overheated. POWER DOWN THE SPA. DO NOT ENTER THE WATER. Contact your dealer or service organization.



A Pump Appears to have been Stuck ON when spa was last powered – M035

POWER DOWN THE SPA. DO NOT ENTER THE WATER.
Contact your dealer or service organization.

* This message can be reset from the topside panel with any button press.

Reminder Messages

General maintenance helps.

Reminder Messages can be suppressed by using the PREF Menu. See Page 12.

Reminder Messages can be chosen individually by the Manufacturer. They may be disabled entirely, or there may be a limited number of reminders on a specific model.

The frequency of each reminder (i.e. 7 days) can be specified by the Manufacturer.

Press a Temperature button to reset a displayed reminder message.

Alternates with temperature or normal display.

Appears on a regular schedule, e.g. every 7 days.

Check pH with a test kit and adjust pH with the appropriate chemicals.

Alternates with temperature or normal display.

Appears on a regular schedule, e.g. every 7 days.

Check sanitizer level and other water chemistry with a test kit and adjust with the appropriate chemicals.

Alternates with temperature or normal display.

Appears on a regular schedule, e.g. every 30 days.

Clean the filter media as instructed by the manufacturer. See HOLD on page 9.

Alternates with temperature or normal display.

Appears on a regular schedule, e.g. every 30 days.

The Ground Fault Circuit Interrupter (GFCI) or Residual Current Device (RCD) is an important safety device and must be tested on a regular basis to verify its reliability.

Every user should be trained to safely test the GFCI or RCD associated with the hot tub installation.

A GFCI or RCD will have a TEST and RESET button on it that allows a user to verify proper function.

Warning:

If freezing conditions exist, a GFCI or RCD should be reset immediately or spa damage could result. The end user should always be trained to test and reset the GFCI or RCD on a regular basis.

Reminder Messages Continued

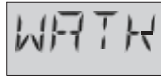
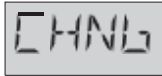

Alternates with temperature or normal display.

Appears on a regular schedule, e.g. every 90 days.

Change the water in the spa on regular basis to maintain proper chemical balance and sanitary conditions.

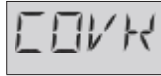

Alternates with temperature or normal display.

Appears on a regular schedule, e.g. every 180 days.

Vinyl covers should be cleaned and conditioned for maximum life.

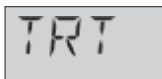

Alternates with temperature or normal display.

Appears on a regular schedule, e.g. every 180 days.

Wood skirting and furniture should be cleaned and conditioned per the manufacturers instructions for maximum life.

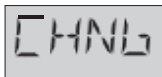

Alternates with temperature or normal display.

Appears on a regular schedule, e.g. every 365 days.

Filters should be replaced occasionally to maintain proper spa function and sanitary conditions.



Alternates with temperature or normal display.

As needed.

Install new mineral cartridge.

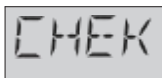

Alternates with temperature or normal display.

Appears on a regular schedule, e.g. every 365 days.

Check your ozone and/or UV generator per your spa manufacturer's instructions.

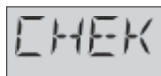
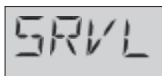

Alternates with temperature or normal display.

Appears on a regular schedule, e.g. every 365 days.

Have a service technician do a check-up on your spa per your spa manufacturer's instructions.

Warning! Qualified Technician Required for Service and Installation

Basic Installation and Configuration Guidelines

Use minimum 6AWG copper conductors only.

Torque field connections between 21 and 23 in lbs.

Readily accessible disconnecting means to be provided at time of installation.

Permanently connected.

Connect only to a circuit protected by a Class A Ground Fault Circuit Interrupter (GFCI) or Residual Current Device (RCD) mounted at least 5' (1.52M) from the inside walls of the spa/hot tub and in line of sight from the equipment compartment.

CSA enclosure: Type 2

Refer to Wiring Diagram inside the cover of the control enclosure.

Refer to Installation and Safety Instructions provided by the spa manufacturer.

Warning: People with infectious diseases should not use a spa or hot tub.

Warning: To avoid injury, exercise care when entering or exiting the spa or hot tub.

Warning: Do not use a spa or hot tub immediately following strenuous exercise

Warning: Prolonged immersion in a spa or hot tub may be injurious to your health

Warning: Maintain water chemistry in accordance with the Manufacturers instructions.

Warning: The equipment and controls shall be located not less than 1.5 meters horizontally from the spa or hot tub.

Warning! GFCI or RCD Protection.

The Owner should test and reset the GFCI or RCD on a regular basis to verify its function.

Warning! Shock Hazard! No User Serviceable Parts.

Do not attempt service of this control system. Contact your dealer or service organization for assistance. Follow all owner's manual power connection instructions. Installation must be performed by a licensed electrician and all grounding connections must be properly installed.

CSA Compliance/Conformité

Caution:

- Test the ground fault circuit interrupter or residual current device before each use of the spa.
- Read the instruction manual.
- Adequate drainage must be provided if the equipment is to be installed in a pit.
- For use only within an enclosure rated CSA Enclosure 3.
- Connect only to a circuit protected by a Class A ground fault circuit interrupter or residual current device.
- To ensure continued protection against shock hazard, use only identical replacement parts when servicing.

- Install a suitably rated suction guard to match the maximum flow rate marked.

Warning:

- Water temperature in excess of 38°C may be injurious to your health.
- Disconnect the electrical power before servicing.

Attention:

- Toujours verifier l'efficacitedu disjoncteur differentiel avantd'utiliser differentiel avantd'utiliser le bain.
- Lire la notice technique.
- Lorsque l'appareillage est installe dans une fosse, on doit assurer un drainage adequat.
- Employer uniquement a l'interieur d'une cloture CSA Enclosure 3.
- Connecter uniquement a un circuit protege par un disjoncteur differentiel de Class A.
- Afin d'assurer une protection permanente contre le danger de shock electrique, lors de l'entretien employer seulement des pieces de rechange identiques.
- Les prises d'aspiration doivent etre equipees de grilles convenant au debit maximal indique.

Avertissement:

- Des temperatures de l'eau superieures a 38°C peuvent presenter un danger pour la sante.
- Deconnecter du circuit d'alimentation electrique avante l'entretien.

Warning/Advertissement:

- Disconnect the electric power before servicing. Keep access door closed.
- Deconnecter du circuit d'alimentation electrique avant l'entretien. Garder la porte fermer.